

TDC Power Products Co.,Ltd
Cheng Yen Electronic Co.,Ltd

DA-16-06

INPUT VOLTAGE **120VAC**
OUTPUT VOLTAGE **6VAC**

ELECTRICAL & MECHANICAL SPECIFICATION



E149474
3G58

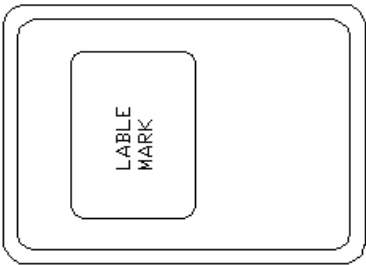

OUTPUT CONNECTOR:
5.5*2.1 FEMALE CONNECTOR

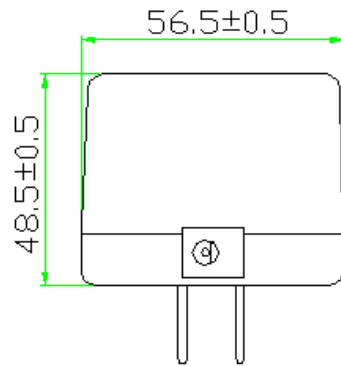
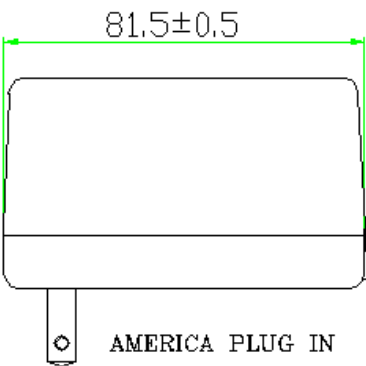

ELECTRONICAL SPECIFICATION

Input Voltage	120	Volts
Frequency (Hz)	60	Hz
Power Rated (W)	25	W
Exciting Current With No load	50	mA Max
Exciting Current With Full load	200	mA Max
Output Voltage	6.0	Volts±5%
Output Current	2.67	Amp
Output Voltage Without Load	6.8	Volts±5%

HI-POT :

Test Time	1	Min
PRI TO SEC	1250	Volts
PRI TO CORE	1250	Volts
SEC TO CORE	1250	Volts
Efficiency	70	%
Insulation Class	B (130)	°C

MECHANICAL SPECIFICATION

Dimensions (L*W*H)	81.5*56.5*48.5	mm
Weight	510	g
Environment:		
Operating Temperature	-10 To 40	°C
Storage Temperature	-20 To 70	°C
Relative Temperature	40°C±2°C	

RELATIVE HUMIDITY 90% RH

Output Cable: **5.5*2.1 FEMALE CONNECTOR**

ELECTRICAL CIRCUIT

