

TDC Power Products Co.,Ltd  
Cheng Yen Electronic Co.,Ltd

**DA-22-20**

INPUT VOLTAGE **120VAC**  
OUTPUT VOLTAGE **20VAC**

**ELECTRICAL & MECHANICAL SPECIFICATION**



**E149474**  
**3G58**

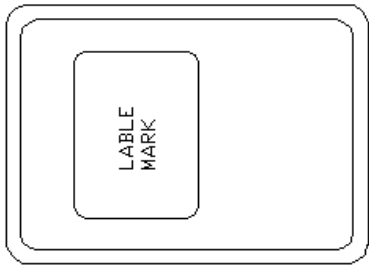

OUTPUT CONNECTOR:  
5.5\*2.1 FEMALE CONNECTOR

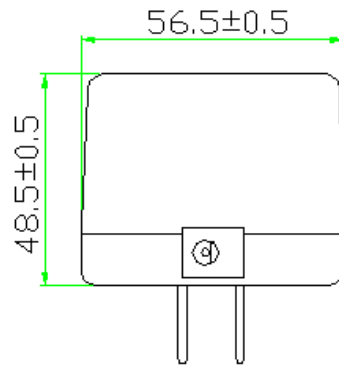
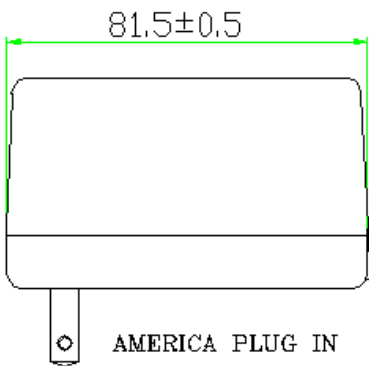

**ELECTRONICAL SPECIFICATION**

Input Voltage	<b>120</b>	Volts
Frequency (Hz)	<b>60</b>	Hz
Power Rated (W)	<b>28</b>	W
Exciting Current With No load	<b>70</b>	mA Max
Exciting Current With Full load	<b>240</b>	mA Max
Output Voltage	<b>20.0</b>	Volts±5%
Output Current	<b>1.1</b>	Amp
Output Voltage Without Load	<b>22.2</b>	Volts±5%

HI-POT :

Test Time	<b>1</b>	Min
PRI TO SEC	<b>1250</b>	Volts
PRI TO CORE	<b>1250</b>	Volts
SEC TO CORE	<b>1250</b>	Volts
Efficiency	<b>70</b>	%
Insulation Class	<b>B (130)</b>	°C

**MECHANICAL SPECIFICATION**

Dimensions (L*W*H)	<b>81.5*56.5*48.5</b>	mm
Weight	<b>525</b>	g
Environment:		
Operating Temperature	<b>-10 To 40</b>	°C
Storage Temperature	<b>-20 To 70</b>	°C
Relative Temperature	<b>40°C±2°C</b>	
<b>RELATIVE HUMIDITY</b>	<b>90% RH</b>	

Output Cable: **5.5\*2.1 FEMALE CONNECTOR**

**ELECTRICAL CIRCUIT**

